

PRODUCT IMAGE / IMAGE DU PRODUIT



GENERAL SPECIFICATIONS / SPECIFICATION GÉNÉRALES

Classification / Classification	Zinc-Silver Oxide Manganese Dioxide
Designation IEC / Désignation IEC	SR45
Cross Ref / Réf croisées	SR936SW, 394, SG9
Nominal Capacity / Capacité Nominale	60 mAh*
<i>*Continuously discharge at 20±2°C under 22kΩ load to 0.9V EPV</i>	
Nominal voltage / Tension nominale	1.55V
Average weight (g) / Poids moyen (g)	0.85g
Shelf Life / Durée de vie	3 years / 3 ans

TEMPERATURE RANGE / PLAGE DE TEMPÉRATURE

Operating temperature range Température d'utilisation	-20°C to +60°C
Recommended applications Applications recommandées	Low- Current electrical devices Appareils électriques à faible courant

DISCHARGE CHARACTERISTICS

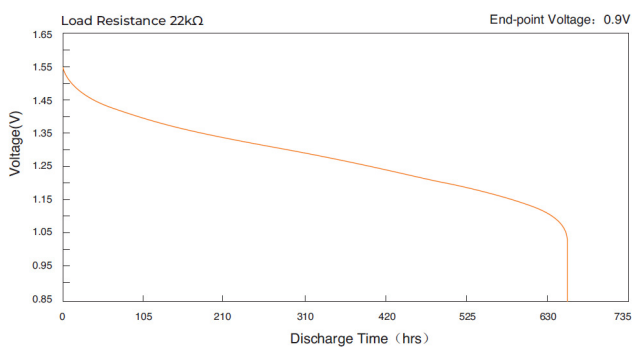

NOMINAL DIMENSION (mm)

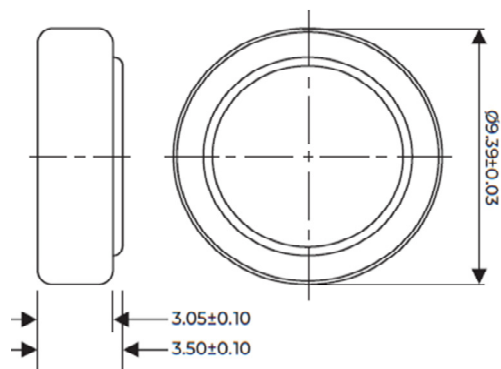

*The above information is generally descriptive only and is not intended as guarantee or warranty
**Uniross reserves the right to alter or amend the design, model and specification without prior notice.