

## GENERAL SPECIFICATIONS

<b>Designation</b> : IEC-CR1216
<b>Classification</b> : Lithium Coin
<b>Chemical System</b> : Lithium / Manganese Dioxide (Li/MnO <sub>2</sub> )
<b>Nominal Voltage</b> : 3.0V
<b>Nominal Capacity</b> : 25mAh (rated at 62kΩ continuous discharge to the end point voltage 2.0V at 20±3°C)
<b>Average weight</b> : 0.7g

## TEMPERATURE RANGE

<b>Storage temperature</b> : - 20°C to + 80°C
<b>Discharge temperature</b> : - 20°C to + 80°C

## PRODUCT DIMENSIONS (IN MM)

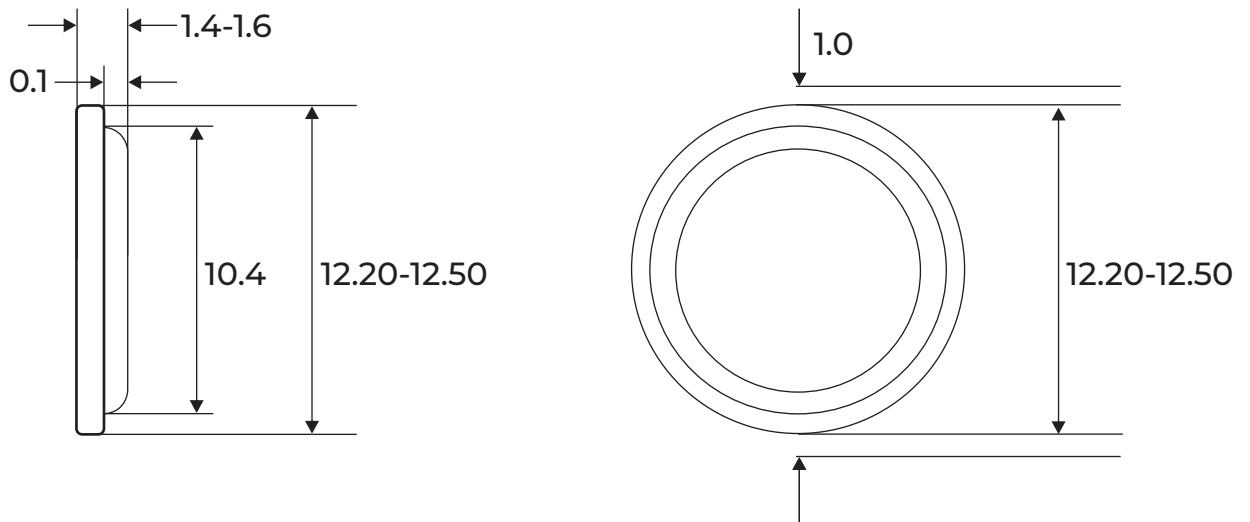

## LEAKAGE PROOF PERFORMANCE

Temperature Range : - 20°C to + 80°C  
Duration : 20 days  
Test Result : No Visible leakage

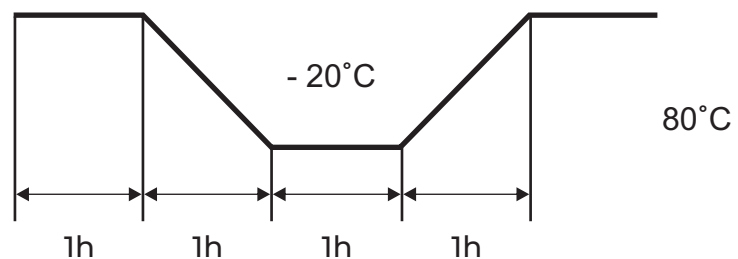

DISCHARGE PERFORMANCE

Discharge Characteristics

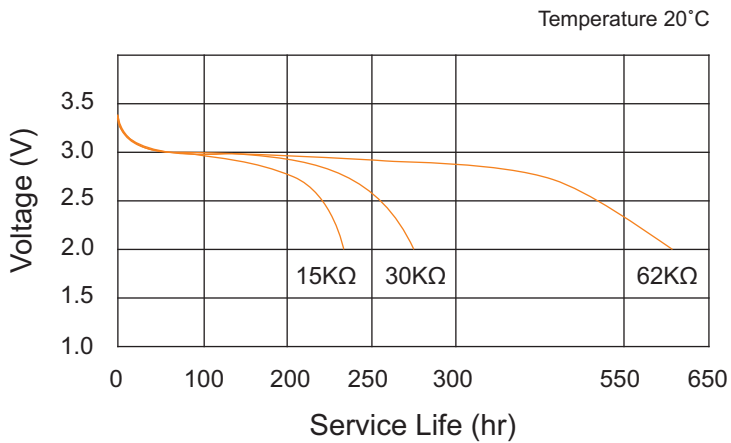

Temperature Characteristics

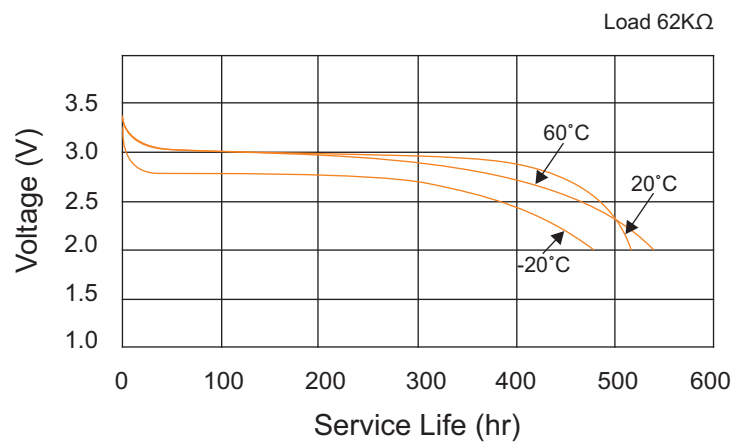

Load-capacity

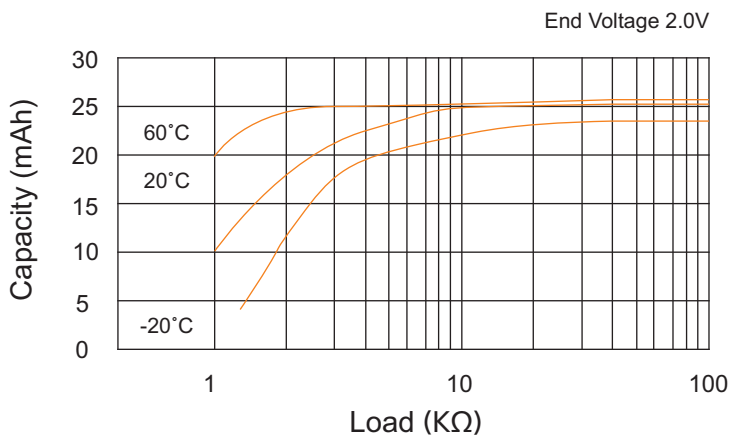

Pulse Discharge Characteristics

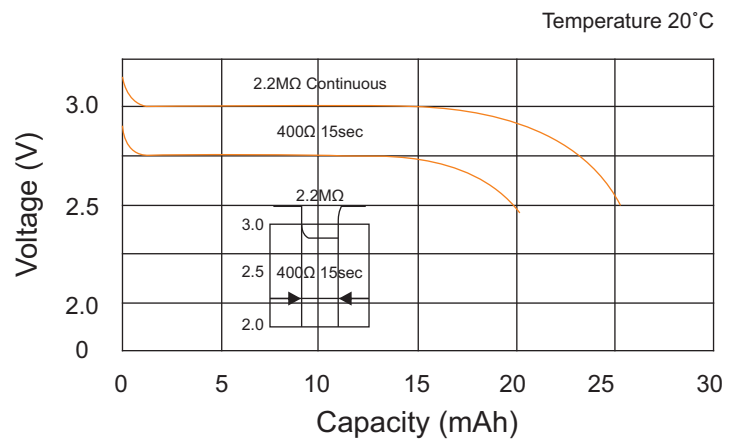

SAFETY / KEY FEATURES

- Lightweight, High Voltage and High Energy Density, Carefully selected materials for long term reliability
- Excellent Discharge Characteristics, Superior Leakage Resistance
- UL Approved Parts
- RoHS compliant

Contact Uniross if the application intended is outside the range of - 20°C to + 80°C.  
 Information and contents in this data sheet are for reference purpose only.  
 Uniross reserves the right to alter or amend the design, model and specs without prior notice.  
 Precautions: Never charge the battery as it is not designed to be rechargeable, may cause leakage or explosion. Insert battery with its positive and negative terminals properly aligned with the corresponding marks on the equipment. Never short circuit, heat, incinerate or dismantle the battery.